



INFINITY

MIDDLE EAST INDUSTRIES

PHONE:
+971 54 591 9030

ADDRESS:
Umm Al Quwain - Umm Dera

MAIL:
Info@infinitymiddleeast.com
WEBSITE:
Infinitymiddleeast.com



INFINITY

MIDDLE EAST INDUSTRIES

**BEST SPORTS WHOLESALER & SPORTS
EQUIPMENT, SPORTS FLOORING
MANUFACTURER IN UAE.**

ABOUT INFINITY

Inifnity Industires designs, produces, and distributes sporting goods and equipment for various sports and recreational activities.

Inifnity Industries play a crucial role in the sports industry by providing athletes, iteams, and enthusiasts with the tools and gear they need to excel in their chosen sports.

OUR VISION

"Our vision is to be a global leader in sports manufacturing, continually pushing the boundaries of innovation and performance. We aspire to empower athletes of all levels, from aspiring beginners to elite professionals, with the highest-quality sports equipment and gear. We are dedicated to creating products that enhance athletic excellence while promoting safety, sustain ability, and inclusivity.

We envision a world where every athlete, regardless of their sport or skill level, can access cutting-edge equipment that not only elevates their performance but also enriches their sporting experience. Our commitment to research and development drives us to pioneer new technologies, materials, and designs, setting new standards for excellence in the sports industry.

Our vision is not only to be a trusted brand but also a force for positive change in the world of sports. We envision a future where athletes achieve their full potential, sports are more accessible, and the joy of competition unites people across borders and cultures. Together, we aim to shape a world where sports empower individuals, instill values, and celebrate the boundless potential of the human spirit."



WE PROVIDE SERVICES IN FIELD OF:

- Padel Court
- Basketball
- volleyball
- Handball
- Football field
- American Football
- Badminton Court
- Athletics Track
- Bowling Alley
- Table Tennis
- Padbol
- Tennis
- Cricket
- Squash
- Golf





ALL KIND OF SPORTS ACCESSORIES

- *Football Accessories*
- *Basketball Accessories*
- *Volleyball Accessories*
- *Tennis Accessories*
- *Gymnastic Accessories*
- *Athletics Accessories*
- *Netball Accessories*
- *Baseball Accessories*
- *Golf Accessories*
- *Badminton Accessories*
- *Swimming Accessories*
- *Boxing Accessories*
- *Table Tennis Accessories*
- *Cricket Accessories*
- *Training Accessories*
- *Lifeguard Accessories*



ALL KIND OF SPORTS FLOORING

Sports flooring: is specially designed flooring used in indoor and outdoor sports facilities to provide a safe and high-performance surface for athletes and sports enthusiasts. It plays a crucial role in enhancing both the performance and safety of sports activities. It's not like regular floors; it's made to help athletes play better and safer.

Different Types Sports floors can be made of wood, rubber, vinyl, or even Artificial grass, depending on the sport.

Keeps You Safe: They have a special cushioning that makes it softer to land on. This helps prevent injuries when players fall or jump.

Helps You Move: Sports floors give you good grip so you don't slip. They also make balls bounce the right way, like in basketball.

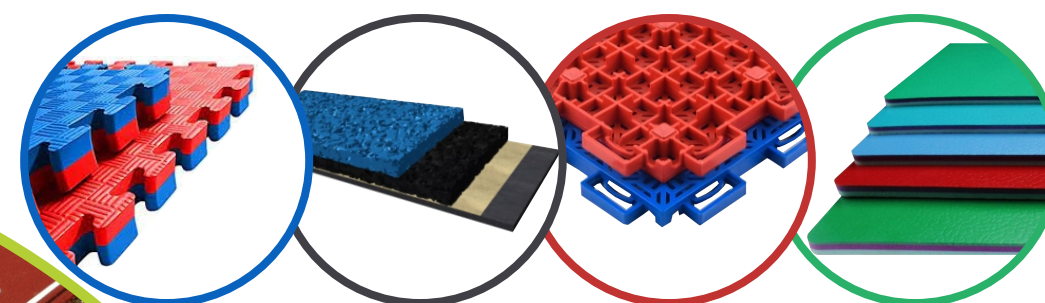

TYPE OF SPORTS FLOORING

- *Polyurethane Floors*
- *Basketball Flooring*
- *Volleyball Flooring*
- *Wooden Flooring*
- *Rubber Flooring*
- *Acrylic Flooring*
- *Padbol Flooring*
- *EPDM Flooring*
- *Carpet Flooring*
- *Football Turf*
- *Runnig Track*
- *Tennis Turf*
- *Vinyl Floors*
- *Padel Turf*





ARTIFICIAL GRASS

Artificial grass has a lot of different type in different weight, thickness and pile height. It is used in different kind of fields such as football, garden, decoration and landscaping. It is mostly used and preferred as football turf. We provide long lasting, maintenance free and simple to manage grass. it is durable and can withstand any weather condition, including the high heat temperatures of the UAE.

We offer a comprehensive selection of artiifical grasvarities, including:

TIGER TURF (UK)



Material:	Polyethylene
Color:	Green
Height:	50 mm
Weight:	1079 g/m ²
Stitches:	8190 m ²
Total weight:	1829 g/m ²
Total height:	52 mm
Country of origin:	United Kingdom

VIETNAME TURF

Structure:	Monofilament
Composition:	PE
Dtex:	14000±10%
Tape thickness:	370µm±10%
Tape width:	1.0mm±10%
Pile height:	60mm±1mm
Stitches per m ²	11340±100
Stitches per m ²	11340±100
Primary backing:	Double layer
Secondary backing:	PU Backing



POLAND TURF

Composition	Polyethylene
Structure	Two Stem Monofilament
Yarn shape	Straight Monofilament
Dtex	10.000
Color	Green Bi colour
Pile height	(50mm)
Stitches per m ²	8.480
Application	Football



CHINA TURF

Pile height	50 mm
Composition:	PE
Dtex:	8800
Stitch	160 s/m ²
Density:	10080 s/m ²
Color:	Field green/apple green
Backing:	PP+LENO+SBR+Latex



FOAM

Foam is used as an underlay or padding beneath artificial grass in certain applications, or shock absorption is desired. The foam underlay can provide a softer and more comfortable surface for activities like play areas, sports field, or landscaping. it can also help with drainage and reduce the risk of injuries.



PADEL COURTS

Padel tennis courts are designed to provide an engaging and social sporting experience. The enclosed nature of the court, combined with the transparent walls, creates a unique atmosphere where spectators can closely follow the action. The smaller court size encourages strategy, quick reflexes, and intense rallies, making padel tennis a highly enjoyable sport for players of various skill levels.

TYPES OF PADEL COURT

SUPER PANORAMIC COURT:

The Super Panoramic (without Corner Column) padel is the latest and highest quality padel court. The super panoramic court represent the modern form of the padel court.

Padel Court dimensions:
20m length x 10m width

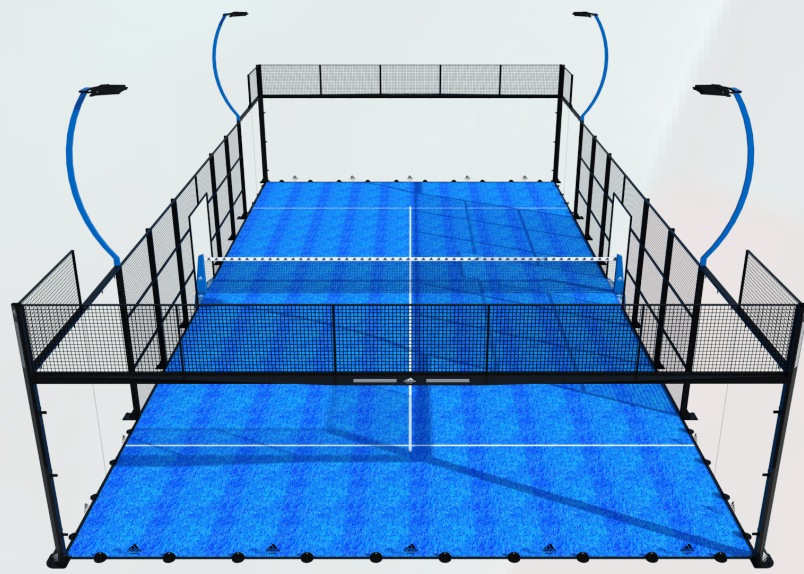
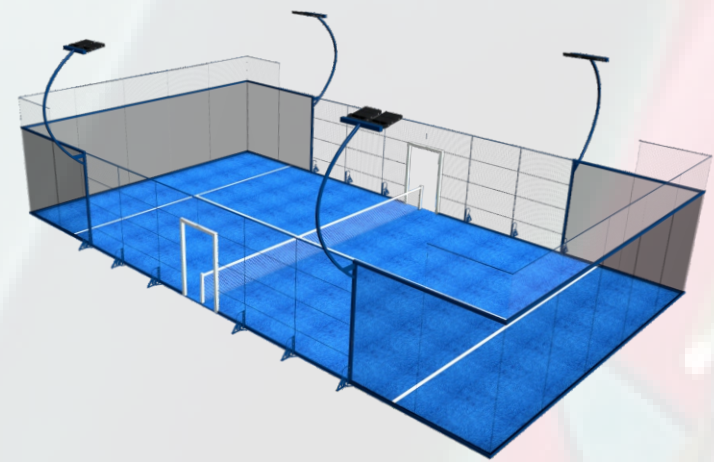

PANORAMIC COURT:

Panoramic padel court offers a pillar free back and side structure providing an enhanced viewing experience for all spectators and players. This high quality court has a strong reinforced steel panoramic frame.

Padel Court dimensions:
20m length x 10m width

MINI PADEL COURT:

Mini Padel court with fantastic design, perfect for children between 3-8 years who want to start playing padel. Suitable for both indoors and outdoors.

Padel Court dimensions:
10m length x 6m width

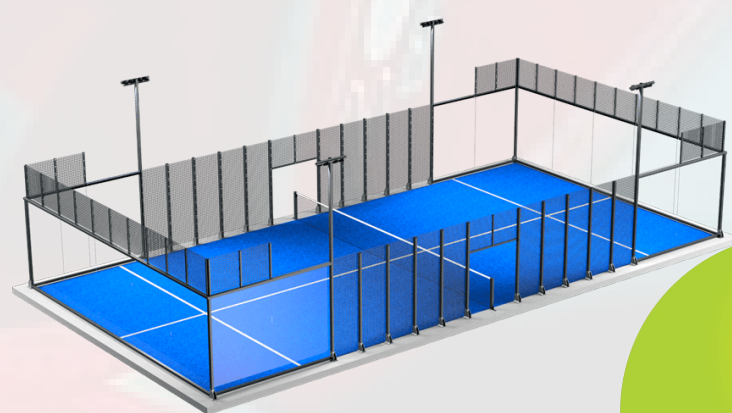

PADEL TURF

This is one of the most common surfaces for padel courts. Artificial grass provides a consistent and durable playing surface. It is low-maintenance and offers good traction for players.

Short Pile Height: Padel grass usually has a short pile height, providing a surface that is suitable for quick and agile movements.

KIND'S OF PADEL TURF

MONDO TURF (spain)

Product Specification

Yarn Composition:	100% POLYETHYLENE
Color:	Green, Blue, Red
Machine Gauge:	3/16
Yarn dtex:	10.000
Stitches: (m ²)	46.200 tufts/m ²
Yarn Height:	10 mm



TIGER TURF (UK)

Product Specification

Yarn Composition:	POLYETHYLENE
Pile Weight: (m ²)	986
Machine Gauge:	3/16
Color:	Green, Blue,
Stitches: (m ²)	35700
Yarn Height:	11/13 mm



VIETNAM TURF

Product Specification

Structure:	Monofilament
Secondary backing:	Black Latex Backing
Machine Gauge:	3/16
Color:	Blue/Diamond Blue
Stitches per 10cm:	25
Yarn Height:	12mm±1mm





RUNNING TRACK

A running track requires antislipping material designed to absorb impacts and prevent slipping. Running tracks are all about the flooring you use that determines its quality and comfort level. We can provide you with flooring that is resistant to the harsh weather of the United Arab Emirates

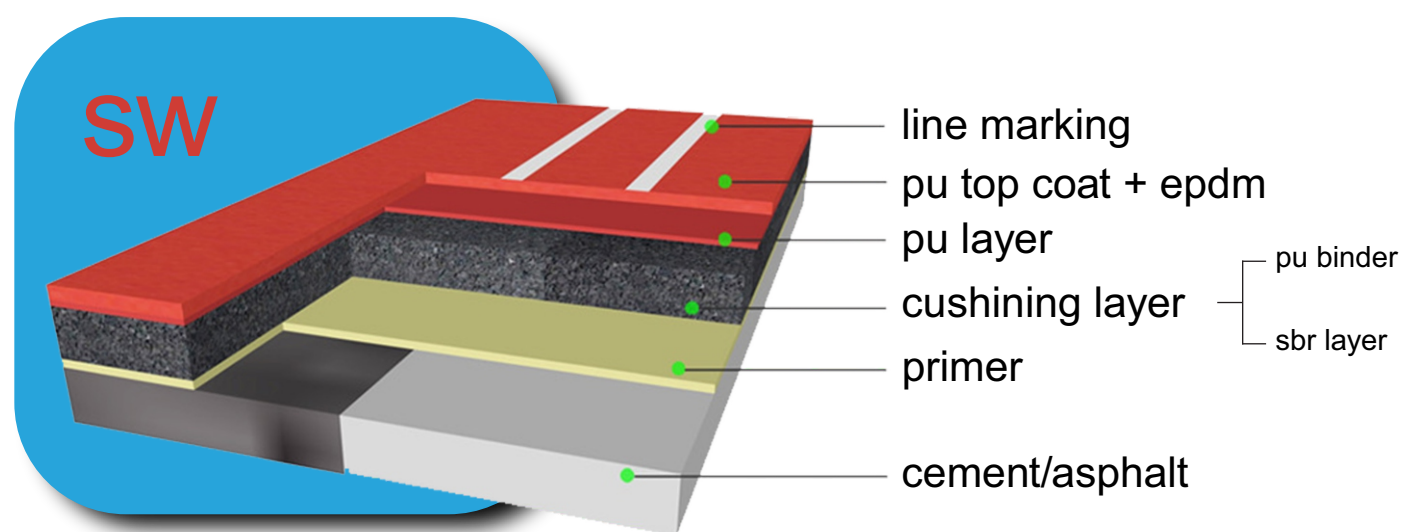

① Surface layer

Material: EPDM particle + polyurethane runway glue

Features: excellent wear resistance, ultraviolet ray resistance and aging resistance. it can be used all day.

② Elastic layer

Material: pure EPDM granule + environmental protective polyurethane sizing agent

Features: environmentally friendly, odorless, no oil return, easy to install.

③ Waterproof binder

Material: one-component polyurethane binder

Features: Excellent waterproof performance, penetration will strengthen the bottom surface and improve the adhesiveness.

④ Foundation

Cement and asphalt

EPDM rubber running track

The **EPDM rubber running track** is made of **EPDM** particles and polyurethane track glue, and features an outstanding wear resistance, ultraviolet ray resistance and aging resistance. It can be used all day and it meets environmentally friendly requirements. This product is suitable for all levels of standard competitions. It has been widely used in training gymnasiums, university sports fields, middle school sports fields, primary school sports fields and other places.

EPDM is a synthetic rubber material primarily composed of ethylene, propylene, and a small amount of diene monomers. The presence of these compounds imparts unique characteristics to EPDM.

1-Weather Resistance: EPDM exhibits outstanding weather and UV resistance, making it an ideal choice for outdoor applications. It can withstand prolonged exposure to sunlight, rain, and temperature fluctuations without degrading.

2-Durability: EPDM is highly durable, with a remarkable ability to resist wear and tear. It has a long service life, even in harsh conditions.

3-Flexibility: EPDM rubber is exceptionally flexible and can maintain its elasticity over a wide temperature range. It remains pliable in extreme cold and does not become overly soft in high heat.

4-Chemical Resistance: EPDM is resistant to a wide range of chemicals, acids, and bases, making it suitable for applications where contact with various substances is expected.

5-Water Resistance: EPDM is impermeable to water, making it a popular choice for waterproofing applications. It is commonly used in roofing, pond liners, and sealing applications.

6-Electrical Insulation: EPDM is an excellent electrical insulator, making it suitable for cable and wire insulation, as well as electrical gasket applications.

PADBOL COURT

Padbol was created in 2008 by Gustavo Miguens in La Plata, Argentina. The first courts were built in 2011 in Argentina, in cities including Rojas, Punta Alta, and Buenos Aires. Then courts were added in Spain, Uruguay and Italy, and more recently in Portugal, Sweden, Mexico, Romania, and the United States. Australia, Bolivia, Iran, and France are the newest countries to adopt the sport.

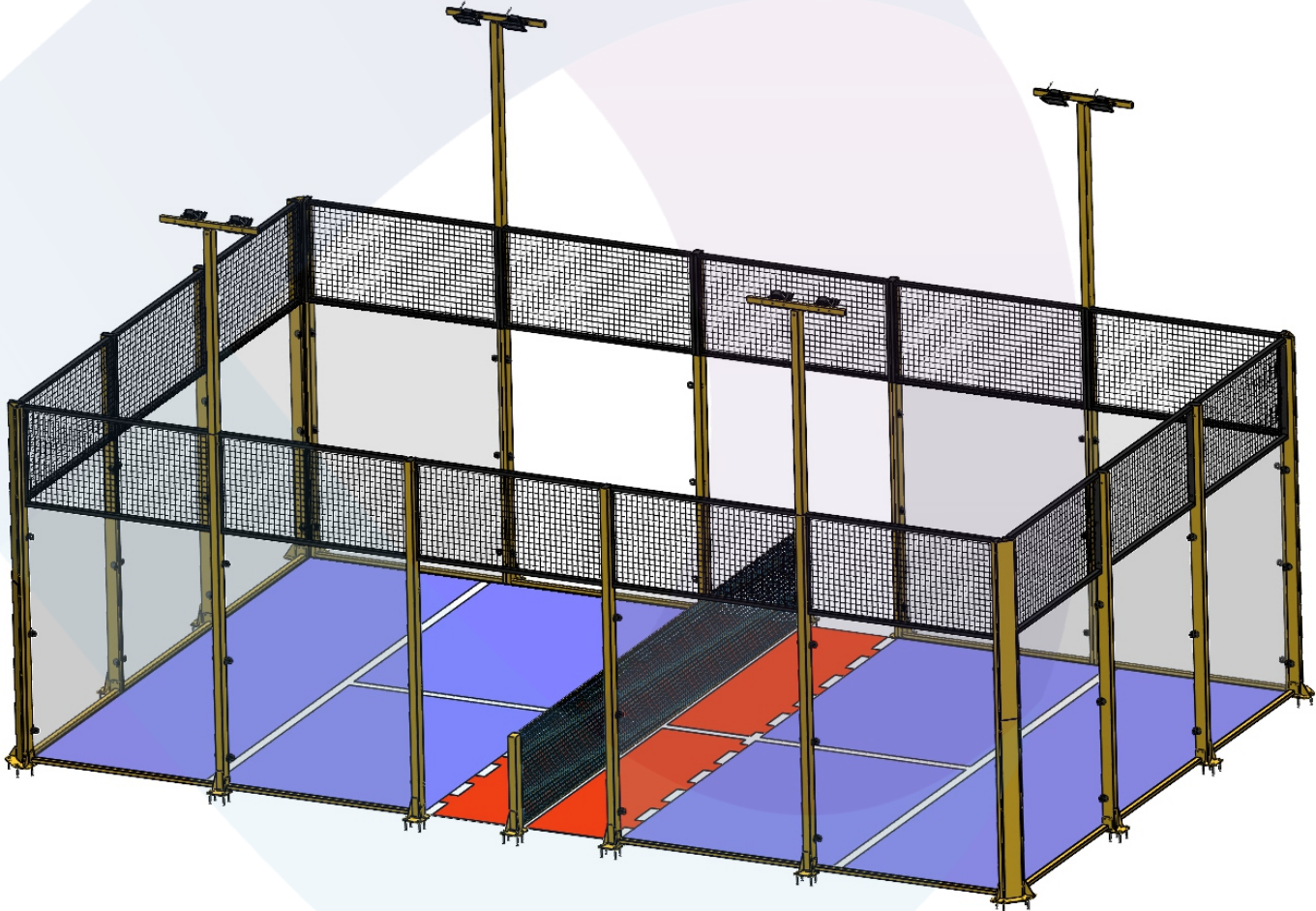

Court dimensions: 10m length x 6m width

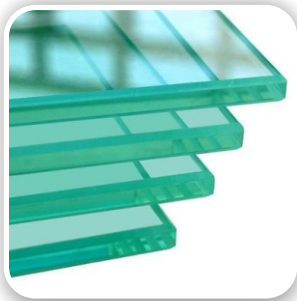

Tempered Glass:

- Type:** Tempered Glass
- Thickness:** 12 mm
- Size:** 2 X 3 meter
- Edge:** Polished
- Color:** Clear



Padbol Net:

- Net Length:** 6 meter
- Net Height:** 92 cm
- Thickness:** 3/4 mm
- Color:** Balack
- Top with steel Cable edging, PVC coated (3,5 / 4,5 mm)

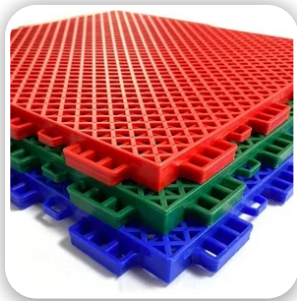

Padbol Flooring:

- Color:** Blue Red
- Size:** 25cm X 25xm
- Thickness:** 13 mm
- Appliction:** Playgrounds
- Advantages:** Non Smell
- Cleaning:** Easy with water

BASKETBALL

Court Dimensions:

A standard basketball court is rectangular and measures 28 by 15 meters (94 by 50 feet). The court features various markings and zones, including a center circle, three-point lines, a key or paint area, and a free-throw line. We are committed to bringing the joy of basketball to your home, school, or facility.

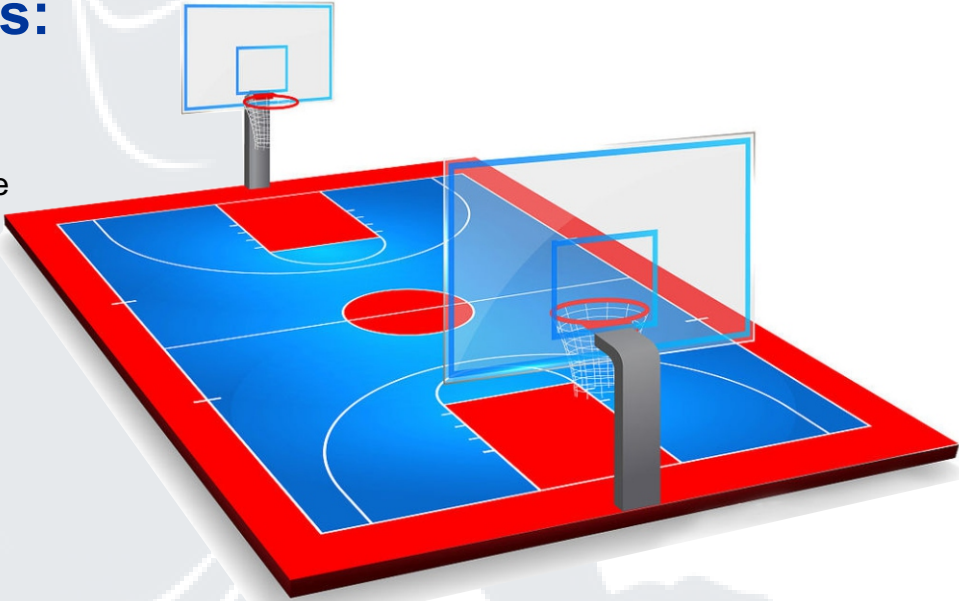

Floor Applications Used in Basketball Court Construction:

Basketball Court With Acrylic Floor.

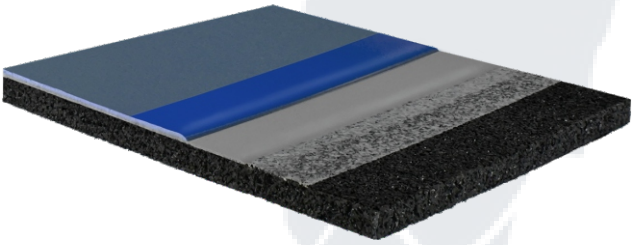

Basketball Court With PVC Floor.



Basketball Court With Tartan Floor.



Basketball Court With Polyurethane Floor.



SPORTS FLOORING

Sports flooring refers to specially designed and engineered surfaces used in various athletic and recreational facilities to provide a safe and high-performance environment for sports activities. These floors are crucial for minimizing the risk of injuries, ensuring proper gameplay, and offering durability to withstand the demands of different sports

Here are some key aspects of acrylic multipurpose flooring systems:

Hard Acrylic Flooring System:

1.Foundation:

Made of compacted aggregates (crushed stone or gravel). Designed to provide stability, drainage and support to the running track.

2.Self-leveling:

Self-leveling concrete is a polymer-modified cement used to create high-compressive smooth flat surfaces.

3.Primer:

to allow the preparation of base for proper strong adhesion to the acrylic coatings.

5.Surface Layer:

The surface layer of hard acrylic sport flooring is a durable and wear-resistant specialized acrylic coating. It offers a smooth, even surface with optimal traction for athletes, ensuring consistent ball response and player stability.

4.Acrylic Coat-1

elastic acrylic resin compound applied as a sealing and smoothing layer consisting of acrylic resin and quartz sand to seal the porosity of base concrete or asphalt.

4.Top Coat:

Acrylic top coat mat finish top coating to make floor easy to clean, anti-slip, elastic, non-porous, UV resistant and highly resilient to harsh weather conditions like Rain, frost or extreme heat.

6.Line Drawing

These markings are typically painted or embedded into the rubber surface using contrasting colors for visibility.

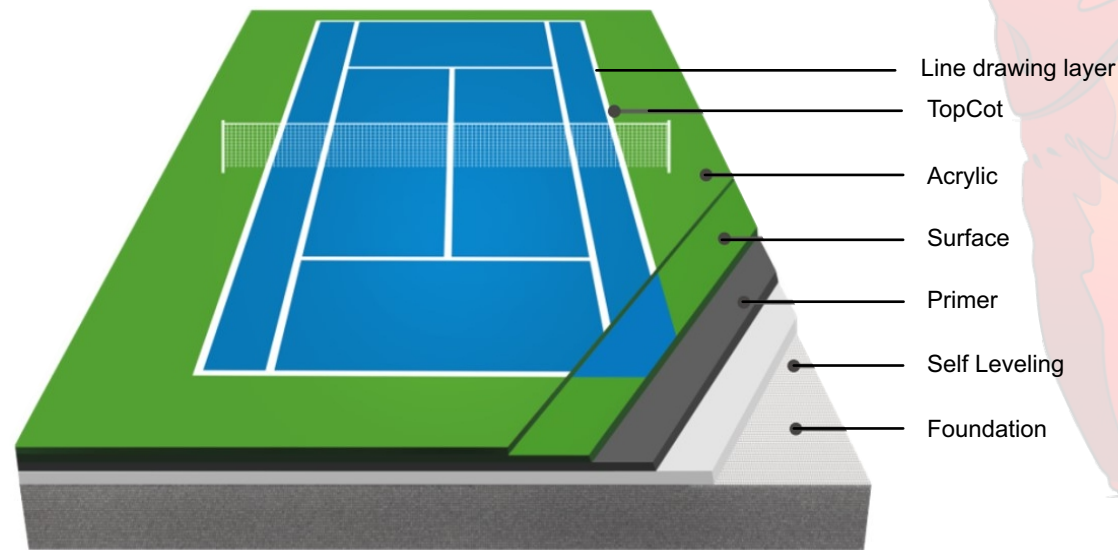

Cushioned Acrylic Flooring System:

The PU resin is the main component of this sport flooring system. It is a mixture of polyurethane resins, fillers, and additives that forms the elastic rubber layer. The number of layers can be increased further so that Cushion Layers will be a minimum of 2 times according to the desired flexibility values on the ground.

1. Self leveling
2. PU Primer
3. SBR (1cm)
4. Surface
5. Acrylic Coat - 1
6. Acrylic Top Coatig

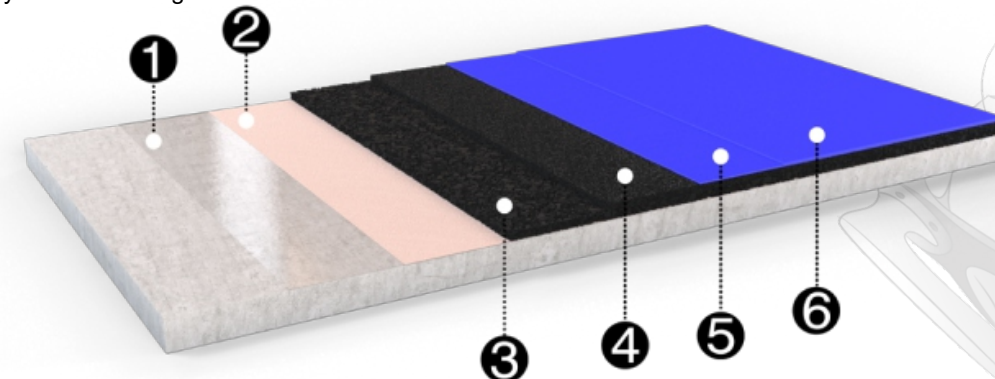

Sandwich System Ground*

1. It is made in 13mm thickness.
2. It consists of 3 layers.
3. SBR + PU + 100% original EPDM + line
4. Its abrasion resistance is high.
5. It is suitable for cleats.
6. It is comfortable for many years thanks to its high UV resistance.
7. It is ideal for very hot and very cold climates.
8. It is waterproof and water is drained from the surface.
9. Maintenance costs are very low.
10. It is used on professional athletics tracks

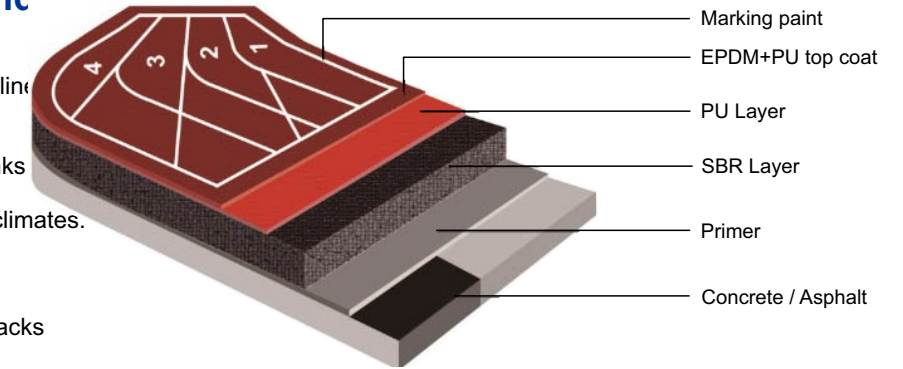

Indoor Sports Hall PVC Flooring:

1. It can be built between 6-10mm.
2. It consists of 3 layers.
3. It has a comfortable and hygienic ground structure.
4. It provides safe gaming performance thanks to its shock absorb
5. Its abrasion resistance is high.
6. It is antibacterial and easy to clean.
7. It is waterproof.
8. Maintenance costs are low.
9. It is preferred in indoor sports halls.



Indoor Sports Hall Parquet Ground:

1. It is produced in 50-65mm thickness.
2. It consists of 4 main layers.
3. Moisture mat + rubber block + plywood + solid parquet + polish + line
4. Parquet grounds are solid made of 100% oak or maple.
5. The ball bounce is in FIBA standards.
6. It has high wear resistance and can be used for many years.
7. Game performance is high.
8. It can be used in hot and cold countries.
9. It can be used up to 15 years after maintenance.
10. It is preferred in professional basketball and multi-purpose halls



TABLE TENNIS TABLES

Infinity middle east offers the best quality table tennis tables in UAE. The playing surface is usually made of wood, coated with a low-friction finish. It is divided into two halves by a net. The standard dimensions of a table tennis table are 9 feet in length, 5 feet in width, and 2.5 feet in height. Choose between indoor and outdoor tables that suit your requirements.



Billiards Pool Table

Yet, our commitment to luxury transcends the world of pool and snooker. At Luxury Pool Tables, we invite you to delve into an extensive collection of gaming tables, including Table Tennis, Table Football, Backgammon, and more, transforming your vision of the perfect games room into a tangible reality.

Standard size pool tables, along with the playing surface dimensions (measured between the noses of the cushions) are:

12-ft (snooker):	140" (356.9 cm) x 70" (177.8 cm)
10-ft (oversized):	112" (284.5 cm) x 56" (142.2 cm)
9-ft (standard regulation size table):	100" (254 cm) x 50" (127 cm)
8-ft+ (pro 8):	92" (233.7 cm) x 46" (116.8 cm)
8-ft (typical home table):	88" (223.5 cm) x 44" (111.8 cm)
7-ft+ (large "bar box"):	78-82" (198.1-208.3 cm) x 39-41" (99.1-104.1 cm)
7-ft ("bar box"):	74-78" (188-198.1 cm) x 37-39" (94-99.1 cm)
6-ft ("small bar box"):	70-74" (177.8-188 cm) x 35-37" (88.9-94 cm)



PADEL RACKETS

WE MANUFACTURE PADDLE RACKETS FOR COMPANIES, CLUBS, BRANDS, SCHOOLS, ETC

SHAPE:

One of the main characteristics of Padel rackets is the shape, since it has the ability to greatly influence the style of the game. In general, we can distinguish between 3 types of shapes:

Surface
A matt or shiny surface finish, or a sand or smooth surface structure for surface.

Shape
The options include teardrop, Daimond, and round padel rackets.

Material
Fiberglass, Carbon, 3K Carbon, 12K Carbon, 18K Carbon, KEVLAR, and TRIAXIAL CARBON.



ROUND SHAPE
Weight approx: 360-370 gr
Profile: 38 mm
Balance: High
Shape: Round
Comp: Carbon 12K
Player: Adult expert
Power/Control: 100/90



DAIMOND SHAPE
Weight approx: 360-370 gr
Profile: 38 mm
Balance: High
Shape: Diamond
Comp: Carbon 18K
Player: Advanced
Power/Control: 100/90

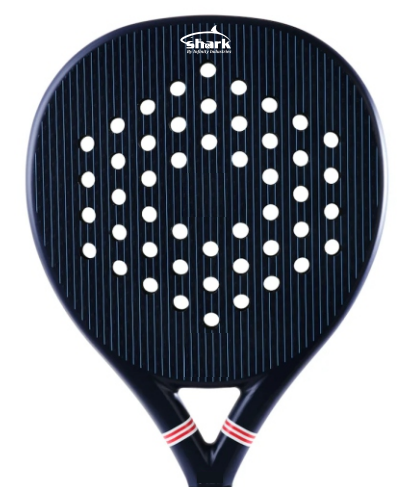

DROP SHAPE
Weight approx: 360-370 gr
Profile: 38 mm
Balance: High
Shape: Drop
Comp: Carbon fiber 3K
Player: Beginne
Power/Control: 100/80

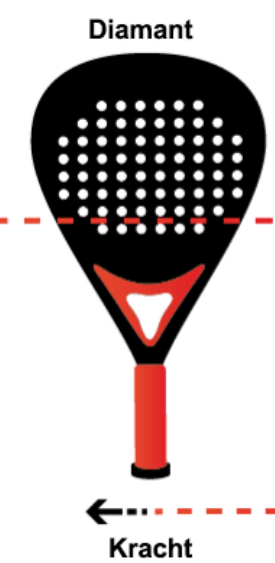

Kracht

Controle

LNDSCAPING

Designing the landscape for a villa involves creating an outdoor space that complements the architecture, enhances the property's aesthetics, and provides functional and recreational areas. Remember, the specific design of a villa landscape can vary based on the villa's location, architectural style, and the preferences of the property owner.



VILLA LANDSCAPING SERVICES WE OFFER

-  Hard Landscaping
-  Soft Landscaping
-  Villa landscape Designing
-  Patios and Walks
-  Maintenance Solutions
-  Installation of Water Features
-  Artificial Grass Installation
-  Plants and Trees Selection
-  Fences, Pillars, Gates
-  Installation of Lighting Fixtures
-  Accessories and Outdoor Furniture selection
-  Design and Construction of Swimming Pools



KIDS PLAY AREA

Creating an engaging and safe play area for kids involves considering various factors to cater to their developmental needs and ensure a fun experience.

Age-Appropriate Zones:

Designate separate play zones for different age groups, considering the unique needs and abilities of toddlers, preschoolers, and older kids.

Colorful and Stimulating Design:

Use vibrant Colors, playful patterns, and themed elements to create an attractive and stimulating environment that captures children's attention.

Soft Play Surfaces:

Install soft and impact-absorbing surfaces like rubber or foam mats beneath play structures to minimize the risk of injuries from falls.



SPORTS NETS

We supply great quality Sports Netting We are one of the leading sports nets suppliers in the UAE, All our sports nets are high quality and made from durable materials such as UV stabilised polyethylene. They are available in a range of lengths and heights to suit your requirements. Our heavy duty boundary nets are suitable for professional sports pitches including tennis, rugby, baseball, basketball, Football, Cricket, and handball. It is suitable for a range of uses including ball stop netting, drone containment, anti bird protection and debris containment. It can be used indoors or outdoors.

Padel net

This Padel net is a simple mesh net in black polythene of 3 mm & 4 mm in diameter. This model offers a standard net that will be perfect for practising your favourite sport.

- Dimensions: 10m x 0.92m
- Material: Polypropylene (PP)
- Mesh/Thick: 2mm / 3mm / 4 mm
- Colors: Black



Tennis net

tennis nets are tapered to meet industry standard and are engineered to withstand and direct sun and moisture.

- Dimensions: 12.8m x 1.07m
- Material: Polypropylene (PP)
- Mesh/Thick: 2mm / 3mm / 4 mm
- Colors: Black



Volleyball net

Indoor and Outdoor Volleyball Nets for recreational and professional volleyball use.

- Dimensions: 9.5m x 1m
- Material: Polypropylene (PP)
- Mesh/Thick: 2mm / 3mm / 4 mm
- Colors: Black / Green



Basketball net

This basketball net is resistant to bad weather. Portable or wall-mounted basketball hoops and backboards.

- Material: Polypropylene (PP)
- Mesh/Thick: 5mm / 7mm
- Colors: White / White red blue



FOOTBALL NET & POST



INFINITY MIDDLE EAST is manufacturing the world class Football Goal posts & Nets. We design the different grades of football Goal post & nets after checking the different market requirements. We have wide range of goal post net that available in different dimension & styles . our Posts & Nets are suitable for the leisure market, training & club market to the competition level market. These Goal Post & Nets can be customized as per customer requirement'.

Football net 3/4 mm



DIMENTION: 2m high x 3m length

Football Post PIPE 3 mm



DIMENTION : 2m hith x 6m length
1 top depth x 1.5 bottom depth



DIMENSION NET SHAPE:
2.5m height x 7.5m length (2 top depth x 2 bottom)



DIMENSION NET BOX SHAPE:
2m height x 6m length (2 top depth x 2 bottom)

STEEL & ALUMINIUM MATERIAL DISCRPTION

ALUMINIUM 3mm

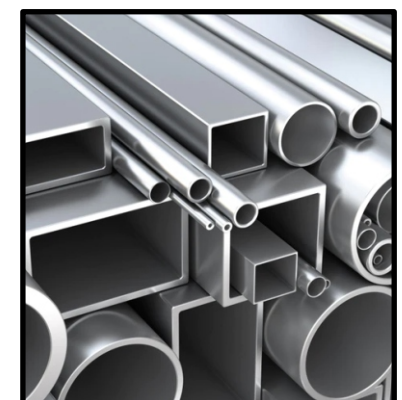

SS STEEL 3mm



MS STEEL 3mm



we can manufacture the post & net on Clint requirement.

SEATING

We provide seating solutions for gyms, large stadiums, auditoriums and lecture halls we can design and customize the seats according to customer requirements, such as the color, size, type and structure of the seats, as well as the place where the seats will be used.

applications

Stadiums

Stadium is a very large usually roofless building that has a large open area surrounded by many rows of seats and that is used for sports events, concerts, etc



Track

Track is usually outdoors, with a large open area surrounded by many rows of seats, used to host sports events, etc.



Gymnasium

Gymnasium is a building that containing space and equipment for various indoor sports activities.



Performance hall

Performance hall is a room, hall or building used for evening performances, concerts and other purposes. People gather to watch performances and so on.



Arena

Arena is a kind of sports platform, which is commonly enclosed and smaller than stadium, basketball, badminton, and swimming are held in it.

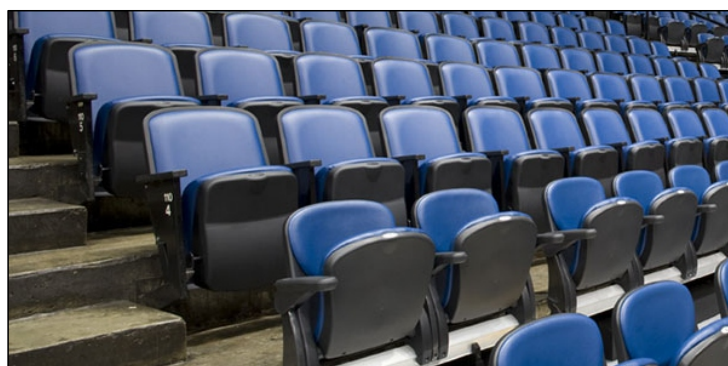

TEAM SHULTERS

aluminum & steel

Portable Team Shelter

Portable Team Shelter, the perfect mobile, self-weighted dugout for multi-sport facilities such as clubs, universities and schools. For ease of transportation and manoeuvrability, our shelter features heavy-duty 360 swivel wheels. This portable dugout can be personalised with the inclusion of school or sports team's logo and colours. Available in a range of sizes.

Polycarbonate thickness:
2mm / 3mm

Steel / Aluminium thickness :
2mm / 3mm



Fixed Premier Curved Team Shelter

Fixed Premier Curved Team Shelter, the perfect choice for football, rugby, field hockey & more. providing resistance to heavy ball impacts. Available in a range of sizes.

Polycarbonate thickness:
2mm / 3mm

Steel / Aluminium thickness :
2mm / 3mm



MATERIAL OF SHELTER

ACRYLIC 2/3mm

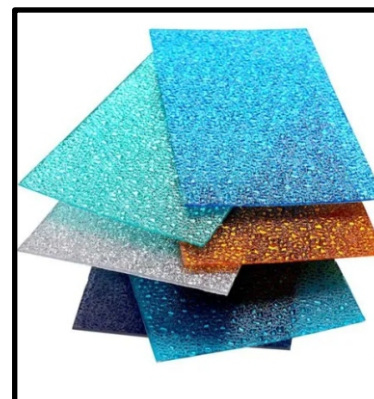

ALUMINIUM 2/3mm



SS STEEL 2/3mm

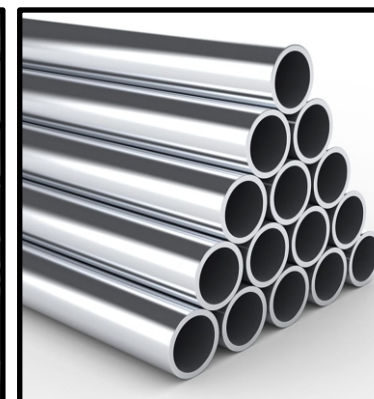

MS STEEL 2/3mm



SHADING

Shades come in various forms to provide protection, privacy, or aesthetic appeal in different settings. These shading systems are essential for creating comfortable and weather-resistant environments in outdoor living areas, patios, and other open spaces, allowing people to enjoy the outdoors regardless of the weather conditions.



AWNINGS

Attached to the exterior of buildings over windows, doors



PERGOLAS

Open structures with cross-beams and a durable open lattice



SHADE SAILS

Tensioned fabric structures in various shapes



CANOPIES

Ideal for shading outdoor events, play areas, or dining spaces

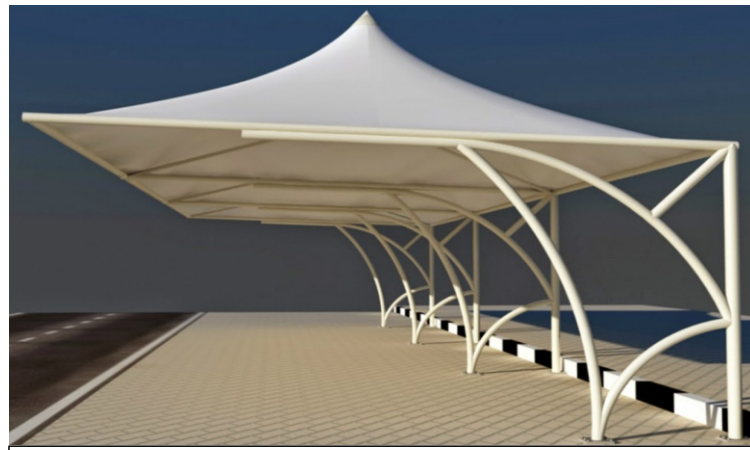

CAR SHADES

Tensioned fabric structures in various shapes



UMBRELLAS

Suitable for shading small areas like outdoor seating or individual lounging spaces

GYM

FLOORING & ACCESSORIES

Gym Flooring:

Gym flooring fulfill specific requirements for commercial and private gyms. We have a great variety in this respect. Common uses include commercial and private gyms. In villas or common area gyms in buildings. The greatest aspect of our gym flooring, is that it absorbs sounds completely. Low sound transference and high absorption make this floor the best option. Solid yet yielding, these floors can carry great weights while absorbing and withstanding great impacts which makes these floors perfect for gyms anywhere.

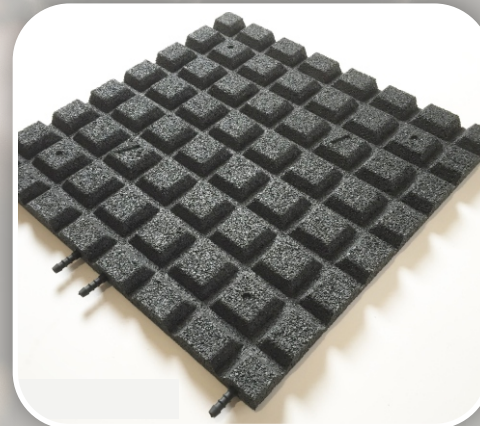

Non Interlocking rubber tile

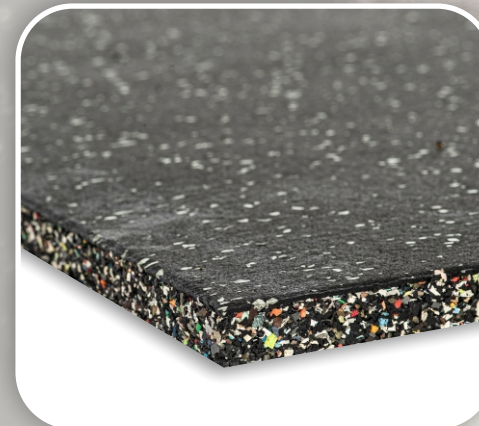

Composites rubber tile

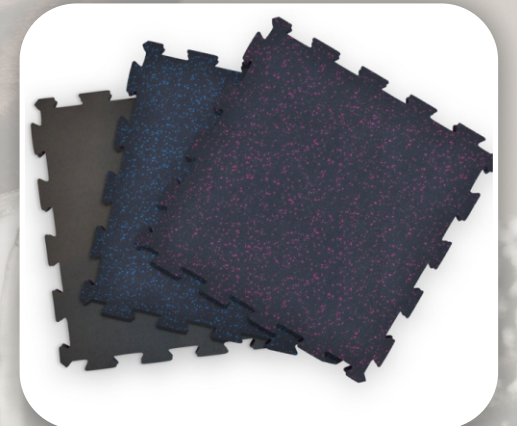

Interlocking rubber tile

GYM ACCESSORIES



Gym equipments



Cable Crossover Machine



Trademill

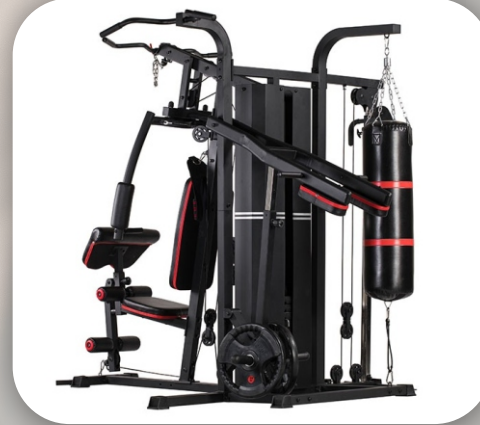

Multi Gym Machine



Cycling Bike



Weight Sit up Bench

SPORTS ACCESSORIES



Basketball Backboards



Basketball Goal post



Badminton Racket



Psychomotor aids set

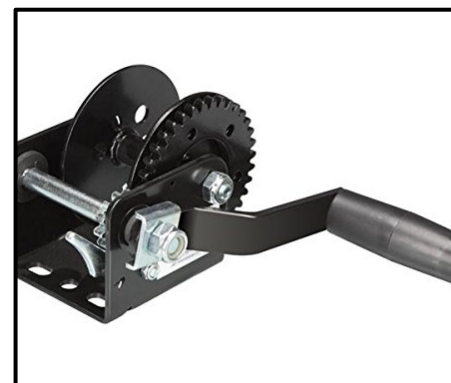

Net Winch



Digital Score Board
football, Basketball, Volyball



Cricket Bat



Metal Stumps



Cricket helmet



Tennis Balls



Sport wear collection

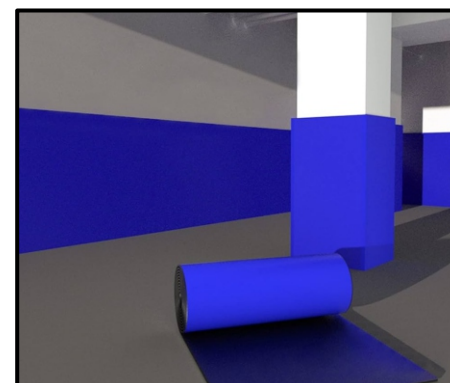

Wall Protection

ALUMINIUM & STEEL WORKS

Infinity has been providing fabrication of Aluminium & steel for Sports construction Industry Infinity now offers the complete range of Football Goal posts, Sports fencing services from our facility in the UAE. Our objective is to be the first choice partner for all your requirements delivering the best value in the industry.

OUR SERVICES



Sports fencing

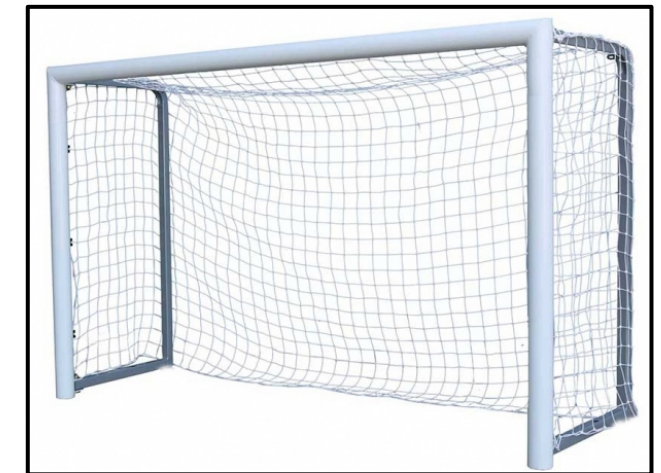

Football goal posts



Team shelters



Ball cart



Umpire chair



Padel goal posts

MACHINES

For Floor & Brushing

As industry leaders, we specialized in providing cutting-edge equipment tailored for professionals in sports facility management. Our unique range of modern machinery focuses on precision turf care. With a commitment to excellence, we empower industry experts with high-performance tools, setting new standards in sports facility maintenance and development.



SMALL PORTABLE BRUSH MACHINE

Engine: Premium
 Rated power: 6.5HP
 Fuel Tank: 6L
 Start mode: Manual



10 HP DIESEL MACHINE DIESEL ARTIFICIAL GRASS BRUSHING MACHINE

Working width: 1500mm
 Brushing capacity: 4000m²/h
 Brushing speed: 4000m²
 Brushing power: 7.3kw 10HP
 Machine weight: 245kg
 Dimension: LxWxH = 1600x1800x1000mm



10 HP DIESEL MACHINE DIESEL ARTIFICIAL GRASS BRUSHING MACHINE

Working width: 1300mm
 Brushing capacity: 3000m²/h
 Brushing speed: 3000rpm
 Brushing power: 5.5kw
 Machine weight: 145kg
 Dimension: LxWxH = 1400x1000x680mm

TRIANGLE BRUSH

Brush Football Field Lawn

Material: wood and nylons, iron
 Model: LTTB1600
 Weight: 30KGS (include packing)
 Brush Capability: 500m²/h
 Brushing width: 1600MM
 Dimension: 1650X250X250MM

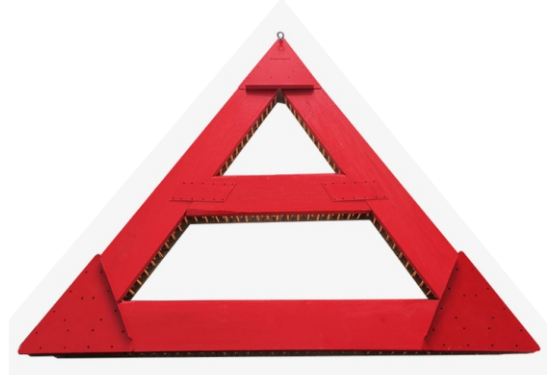

RUNWAY LINE DRAWING MACHINE

Engine Power: 5.5Hp
 Marking rate: 0.5-3KM/H
 Common pressure: 10-20Mpa
 Max flow rate: 1.2L/Min
 Weight: 95Kg
 Appearance measurement: 1000*700*880mm



EPDM HEATING TROWELING MACHINE

Engine Power: 5800W
 Voltage: 220 V
 Speed regulation: 6-gear regulation
 Disk diameter: 52cm
 Weight: 20Kg
 Paving Capability: 200m²/h
 Troweling width: 500mm



HIGH OUTPUT CRUSH INTEGRATED

AUTOMATIC MULTI-FUNCTIONAL ARTIFICIAL TURF- RUBBER INFILL

Loading capacity: 800 kgs
 Sand filling width: 1100mm
 Motor power: 800w
 Gasoline engine power: 5.5HP
 Moving Speed: 1-20km/h
 Sand filling width: 1100mm
 Weight: 450kg



ARTIFICIAL TURF INSTALLATION TOOLS



GRASS LINE CUTTER
Line Cutter for artificial grass cutting of variable width of straight lines &



TURF FIX CIRCLE CUTTER
Tool for circular cutting
size : 232x232x240mm

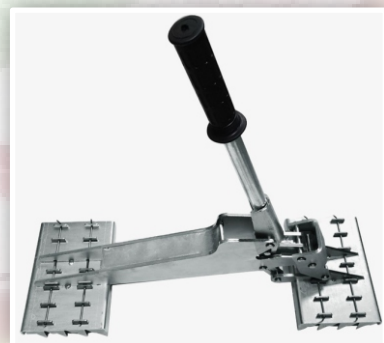

GRIPPING TONGS
Gripping tongs for a fast and easy alignment of artificial grass strips.



GRIPPING TONGS
Gripping tongs for a fast and easy alignment of artificial grass strips.

SEAM FIXER
Pressure tool for the solidified connection of seams of artificial grass and glue coated seam tape
size: 35x200x240mm



GLUE APPLICATOR
applicator for glue coating of artificial grass.
Size: 760x3

